

# Pendant

## INSTRUCTION MANUAL

### Safety Warnings

- This product is only suitable for connection to a 240V~50Hz supply in accordance with current IEE wiring regulations. It should be installed in accordance with local building regulations and is for domestic ceiling use only. It is not suitable for a bathroom location.
- Before installing your light fitting always switch off the mains supply and remove the appropriate fuse or switch off the appropriate circuit breaker before commencing installation.
- This is a Class II, Double Insulated product  This fitting does not require an Earth, and Live or Neutral **must not** be connected to Earth. The terminal blocks are supplied according to requirements of the fitting.
- Never fit bulbs of a higher wattage than those specified on the label, as these may cause overheating and damage the fitting.
- If you are in any doubt about your competence please consult a qualified electrician.
- If any modification is made it will invalidate the warranty and may render the product unsafe.

### Care Information

Allow 10 minutes to cool before replacing, adjusting or cleaning.  
Clean with a dry cloth only. Do not use liquid or abrasive cleaners on this product.

### Assembly/ User Instructions

#### Before you start





Please read these instructions carefully before fitting and retain for reference. Check the packaging and make sure that you have all the required parts. Follow each assembly step in order to prevent incorrect assembly. Ensure that the product is fully assembled as illustrated before use.

#### The Light pack contains:

Light fitting.  
Terminal connection block(s).  
Fixing pack.  
Decorative rods, as shown below.

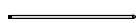
#### The following tools may be required:

Selection of cross and flat head screwdrivers.  
Electric drill and assorted drill bits.  
Wire strippers.  
Electrical insulation tape.

NO	PARTS LIST	Qty	NO	PARTS LIST	Qty
E		18	G		36
F		36	H		18

**These assembly diagrams are intended as a guide – if in doubt consult a qualified electrician.**

1. Decide on the position of the light fitting, or remove existing light fitting. Note the position of the electrical connections. Ensure there is a solid mounting surface, preferably a wooden joist or joist bridge to support the weight of the light fitting.
2. If you want to reduce the overall length of the fitting it is essential that this is done before the fitting is mounted to the ceiling, or connected to the mains supply. Remove the chain links until the desired length is reached. The cable must now be shortened and the excess cable cut and re-connected to the terminal block. Feed the cable up through the plastic bush and form a loop above the ceiling cup, moving the figure of 8 cable restraint down the exposed cable. **NOTE: The electric cable must always be longer than the chain to prevent strain being placed on the cable. If you are unsure about your ability to do this, we recommend you contact a qualified electrician.**
3. Fit the bulbs, being careful not to touch it with your bare hands - use a cloth or gloves. **NOTE: Never fit bulbs of a higher wattage than those specified on the label.**

# Assembly/ User Instructions Continued

4. Assemble the decorative rods, as shown in Figure 1. Fit levels 1-4 prior to hanging.
5. Referring to Figure 2, remove the two side screws (4) and retain for re-use. Use the fixing bracket (1) as a template to mark the screw holes. Make the screw holes and secure to the ceiling with appropriate screw fixings (2).
6. Support your fitting and connect the house wiring to the terminal block (3) – see expanded wiring details below.  
**NOTE: This is a Class II fitting and must NOT be earthed.** Any loose terminal blocks – not secured to ceiling cup – should always be covered with 2 layers of good quality insulation tape.
7. Secure the ceiling cup over the bracket by using the screws (4) removed in Point 5.
8. Fit decorative rods levels 5-7, per figure 1.
9. Turn on the power and test.

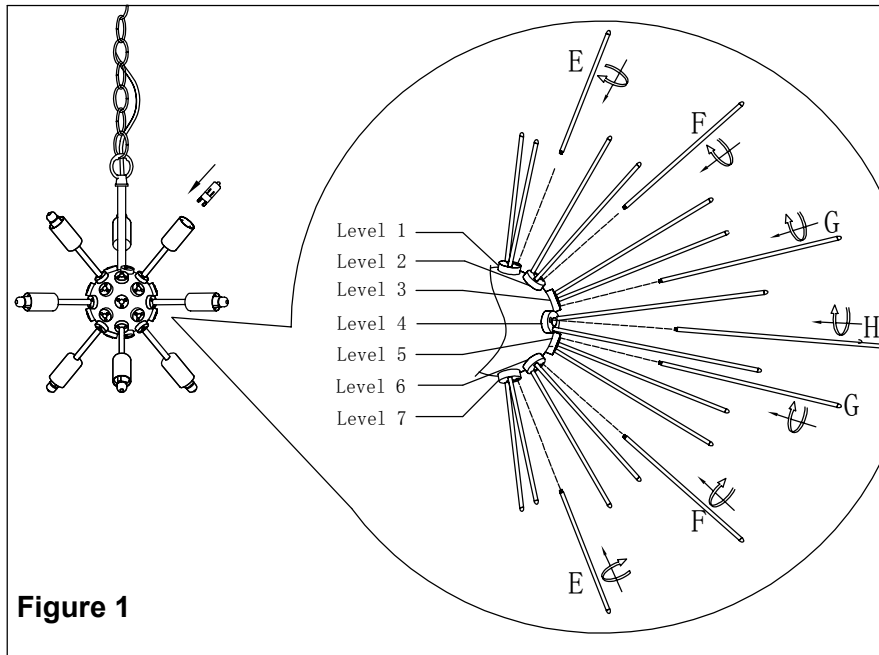

Figure 1

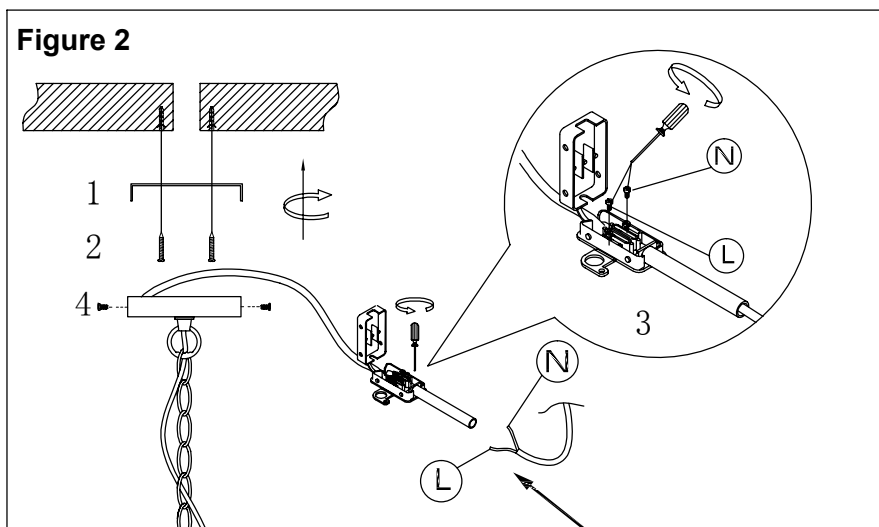
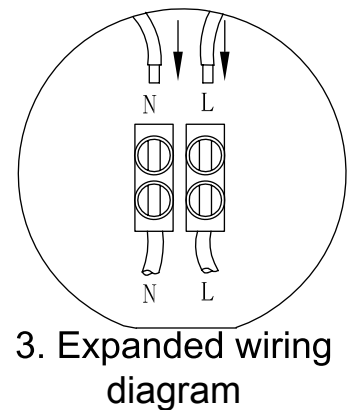

Figure 2



- EN Scan QR code for multi-language
- FR Scannez le code QR pour plusieurs langues
- ES Escanee el código QR para varios idiomas
- PL Zeskanuj kod QR dla wielu języków
- DE Scannen Sie den QR-Code nach mehreren Sprachen
- IT Scansiona il codice QR per multilingua